

WDRV-5063M

WDRV-7063M

[TFT LCD COLOR MONITOR]

WDL-5001M / WDL-7001M

WDRV-5041M / WDRV-7041M

WDRV-5043M / WDRV-7043M

WDRV-5061M / WDRV-7061M

Owner's Manual



Please read carefully before using and keep in a safe place.
Design and specifications are subject to change without notice.

Owner's Record

The model and serial numbers are located at the rear.
Record the serial number in the space provided below.
Refer to these numbers whenever you call your dealer regarding this product.

MODEL: WDL-5001M WDRV-5041M WDRV-5043M WDRV-5061M WDRV-5063M
WDL-7001M WDRV-7041M WDRV-7043M WDRV-7061M WDRV-7063M

Serial Number: _____

Warnings



WARNING
RISK OF ELECTRIC SHOCK
DO NOT OPEN



To reduce the risk of electric shock do not remove cover (or back).
NO user serviceable parts inside. Refer servicing to qualified service personnel.



The lightning flash with arrowhead symbol within an equilateral triangle is intended to alert the user to the presence of "dangerous voltage" within a product's enclosure that may be of sufficient magnitude to constitute a risk of electric shock.



The exclamation point within an equilateral triangle is intended to alert the user to the presence of important operating and maintenance (servicing) instructions in the literature accompanying the appliance.

Table of Contents

1. Table of Contents	3
2. Features/Precautions	4
3. Packing List / Installation	7
4. Functions	
Monitor	8
Remote Control	9
5. System Wiring	
WDRV-5043M/7043M	10
WDRV-5063M/7063M	10
WDL-5001M/7001M	11
WDRV-5041M/7041M	11
WDRV-5061M/7061M	11
6. Operation	12
7. Troubleshooting	14
11. Specifications / Dimensions	16

Before operating the set, please read this manual carefully

Features

WDRV-5063M/7063M is specifically designed as an automotive vision system.

- High Resolution 5" / 7" TFT LCD Panel
- Free Input Voltage (DC 12V~DC 32V)
- NTSC/PAL Compatibility
- 3 Camera Inputs
- Automatic Picture Display (3 Triggering Functions)
- Auto Scanning Function
- Dimmer Fuction
- Built-in Speaker
- OSD (On Screen Display)
- Weatherproof (IP54)
- Easy Release Bracket

Precautions

Warning

To prevent fire or shock hazard, do not expose the set to rain or moisture. Do not rub or strike the Active Matrix LCD with anything hard for this may scratch, mar, or damage the Active Matrix LCD permanently.

Regulatory Information

This equipment has been tested and is in compliance with the limits for a Class B digital device, pursuant to part 15 of the FCC Rules. These limits are designed to provide reasonable protection against harmful interference when the equipment is operated in a residential installation. This equipment generates uses and can radiate radio frequency energy and, if not installed and used in accordance with the instruction manual, may cause harmful interference to radio communications. However, there is no guarantee that interference will not occur in a particular installation. If this equipment does cause harmful interference to radio or television reception, which can be determined by turning the equipment off and on, the user is encouraged to try or correct the interference by one or more of the following measures.

Do not remove the cover

To reduce the risk of electric shock and maintain the quality of the product, please do not remove the cover.

Please follow the instructions of the wiring diagram in the Installation Guide.

Keep small articles out of the reach of children

Store small articles (screws, etc.) in places not accessible to children.

If swallowed, consult physician immediately.

Stop using immediately if a problem appears

When problems appear, stop using the system immediately and contact the dealer from whom you purchased the equipment. Some problems which may warrant immediate attention include a lack of sound, noxious smoke being emitted from the unit, or foreign objects dropped inside the unit.

Do not use this equipment outside the vehicle

Do not use this equipment for purposes other than those listed for the vehicle.

Failure to do so may result in an electric shock or an injury.

Stop the vehicle before carrying out any operation that could interfere with your driving

If the operation of the unit (such as turning on or turning off the monitor, etc.) interferes with your driving, stop the vehicle in a safe location before attempting operation.

Temperature

Before turning your unit on, be sure the temperature inside the vehicle is between -10 and +50 .

Maintenance

If you have problems, do not attempt to repair the unit by yourself. Return it to your purchasing dealer.

Caution

Do not attempt to modify this product in any way without written authorization. Unauthorized modification could void the user's authority to operate this product.

Power

This set operates on DC power. The voltage is as indicated on the label on the back cover. Never apply AC power to the set directly. Do not allow anything to rest upon or roll over the power cord, and do not place the set where the power cord is subject to damage.

Service

Never remove the back cover of the monitor, this can expose you to high voltage and other hazards. If the monitor does not operate properly, unplug it and call your dealer.

Location

Position your monitor so that no bright light or sunlight will shine directly on the screen. Make sure that the monitor is placed in a position that allows a free flow of air. Do not cover the ventilation openings on the back cover.

Cleaning

Unplug the monitor before cleaning the face of the LCD Screen. Dust the monitor by wiping the screen and cabinet with a soft, clean cloth. If the screen requires additional cleaning, use a clean damp cloth. Do not use liquid or aerosol cleaners.

Packing List

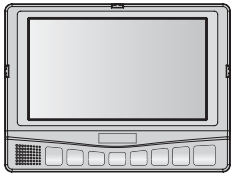

Set [TFT-LCD Monitor]



Remote Controller
(Option)

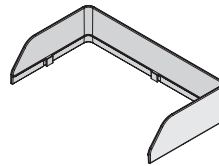

Sunshield



Power and Video
Input Cable



Manual



Easy Release Bracket
(Option)

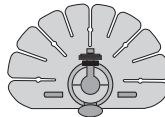

Stand Bracket
(for WDL Series)

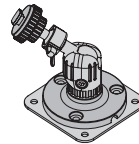

Stand Bracket
(for WDRV Series)



2 Batteries (Type AAA)
for Remote Controller
(Option)

Installation

Install the monitor on a surface which can with stand more weight than 5Kg (11 lbs)

- Clean the surface before installation
- Remove the protective paper covering the bottom of the bracket
- Stick the provided bracket on the surface and fix it firmly with the screws.

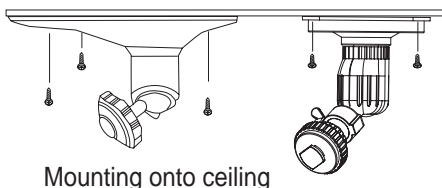

Mounting onto ceiling

Mounting on the floor, console, etc.

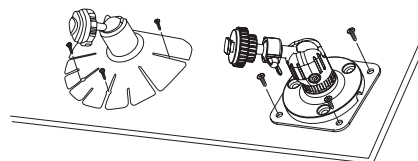

- Adjust the angle of the monitor and fasten the handle screws tightly.

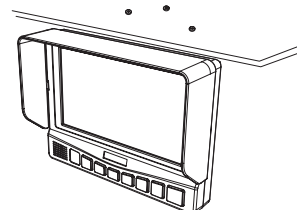
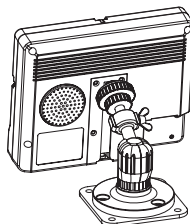
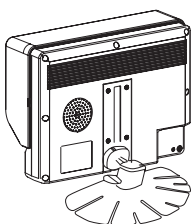

Functions

MONITOR

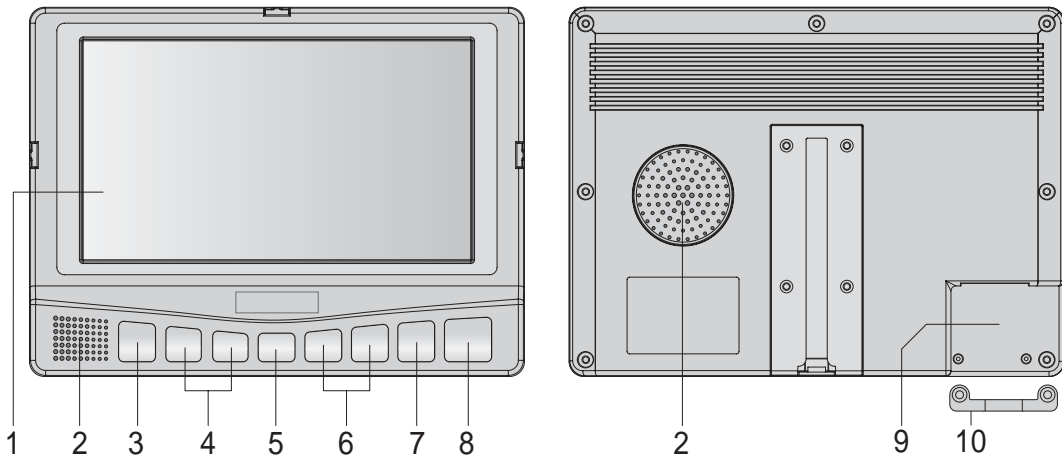

NO	MENU	DESCRIPTION
1	Protection Window	Non Reflection and protection of LCD. (Option)
2	SPEAKER	Sound out 0.5W X 2 Max.
3	IR	Remote control sensor. (Remote control is optional)
4	UP/DOWN	Use select items in the on screen menu, press UP/DOWN buttons to control rear view motorized camera. Camera 2 only.
5	CAMERA/SCAN	Press CAMERA/SCAN button to change video source. If button is held down over 1 second the setting will be changed to the auto scan mode.
6	VOLUME	Press to increase or decrease the volume and menu control.
7	MENU	Displays main menu on screen.
8	POWER/DIMMER	Press button to control dimmer. By pressing button over 1 second will turn monitor on/off. (Red LED light off)
9	CONNECTOR	Input cable (Composite Video, Audio, Power)
10	BRACKET	Bracket for fixing cable. (Option)

REMOTE CONTROL (Option)

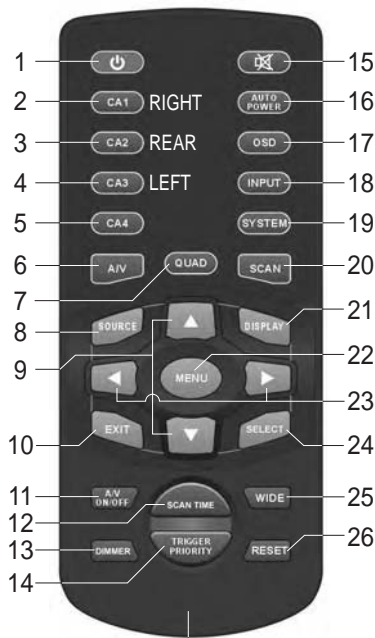

Battery

"AAA" Size(1.5V x 2)

No.	Button	Description
1	POWER	On/off power of LCD monitor
2	CA1 (RIGHT)	Change camera1 RIGHT video
3	CA2 (REAR)	Change camera2 REAR video
4	CA3 (LEFT)	Change camera3 LEFT video
5	CA4	None
6	A/V	None
7	QUAD	None
8	SOURCE	Press to display all available video source
9	UP/DOWN	Use select items in the on screen menu, press UP/DOWN buttons to control rear view motorized camera (Camera 2 only)
10	EXIT	Turn menu off
11	A/V ON/OFF	A/V source on/off
12	SCAN TIME	Scanning function up to 9 seconds for selected camera.
13	DIMMER	Dimmer control button
14	TRIGGER PRIORITY	Sets priority video source when more than two trigger signals enter at the same time
15	MUTE	Mutes sound
16	AUTO POWER	The power of LCD stays on/off
17	OSD	Sets operating OSD display
18	INPUT	Trigger function on/off
19	SYSTEM	Video system control (NTSC/PAL) - Option
20	SCAN	Automatic scan when source is connected to video.
21	DISPLAY	Preset display mode
22	MENU	Displays menu options on screen
23	VOL	Increase/decrease sound
24	SELECT	ON/OFF function select
25	WIDE	Picture ratio control (Wide/Normal) - 7" only
26	RESET	Initialize to factory default (Press button over 5 seconds)

System Wiring

[WDRV-5043M / 7043M]
[WDRV-5063M / 7063M]

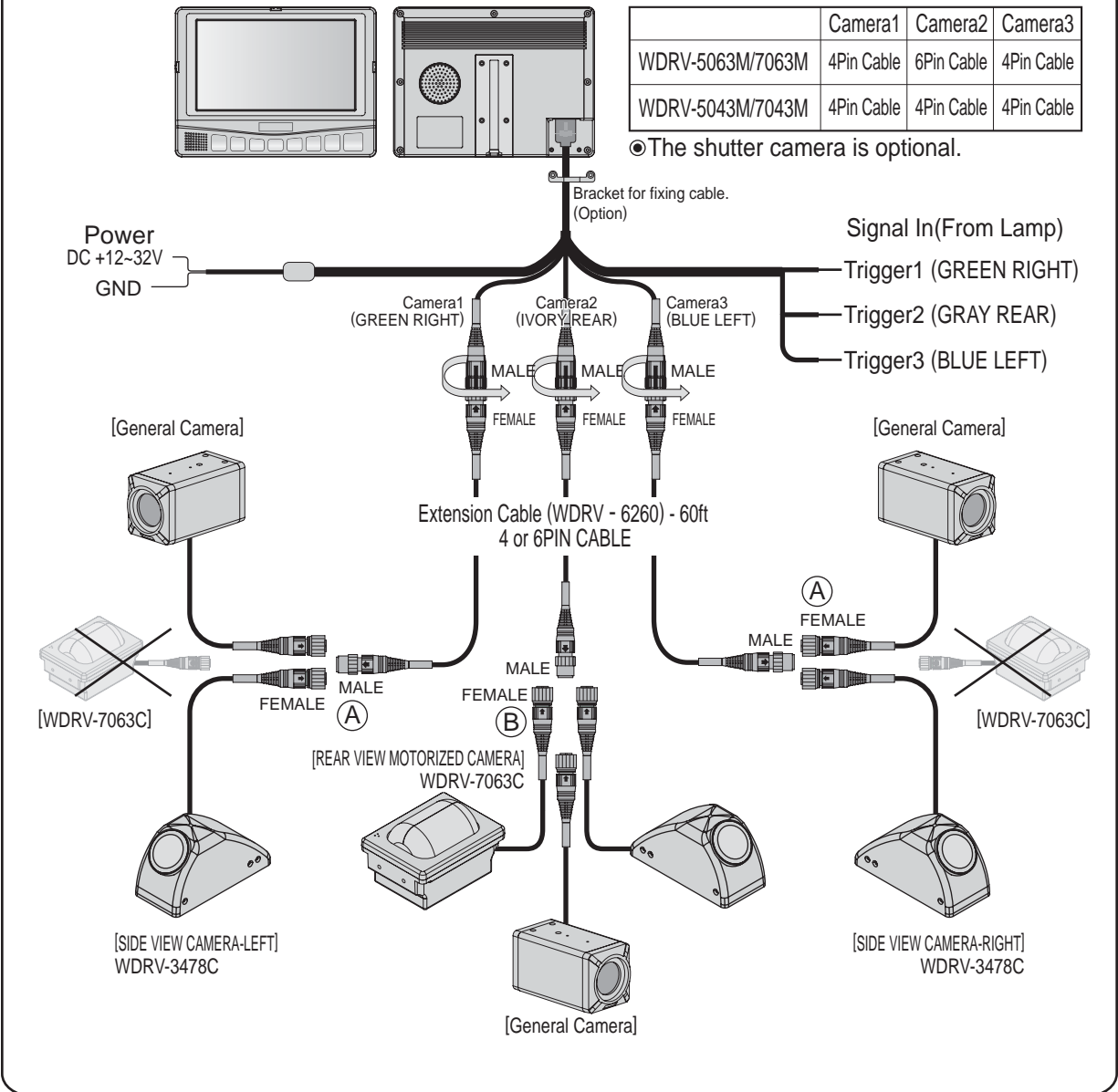

[WDL-5001M / 7001M]

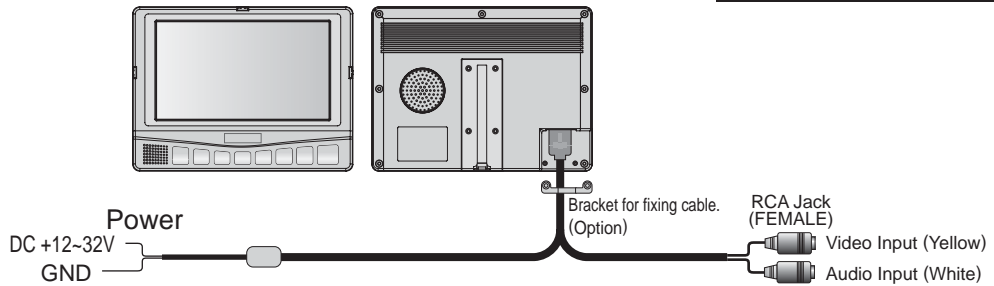

[WDRV-5041M / 7041M]
[WDRV-5061M / 7061M]

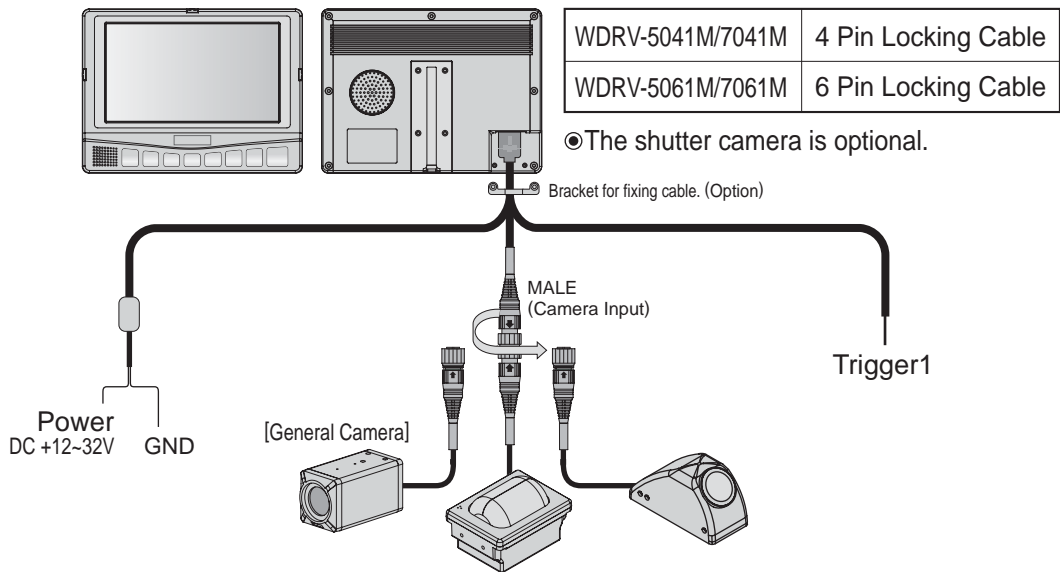

WDRV-3478C Pin Connection
[SIDE VIEW CAMERA]

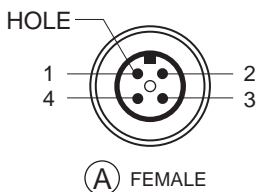

Pin No.	Description
1	S/D (GND)
2	AUDIO
3	VIDEO
4	DC +12V

WDRV-7063C Pin Connection
[REAR VIEW MOTORIZED CAMERA]

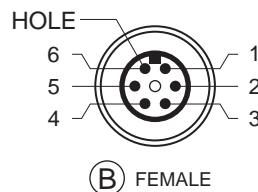

Pin No.	Description
1	VIDEO
2	DC +12V
3	MORTOR +
4	AUDIO
5	MORTOR -
6	GND



Operation

- ※ 1) Three view system: You can hear sound all the time.
- 2) On view or security camera system: Audio available only when vehicle is in reverse.

MENU  

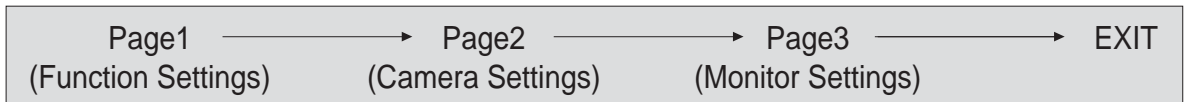
- Press to enter setup menu
- Selectable OSD menu disappears within 5 seconds if there is no command given.
- Menu Toggle

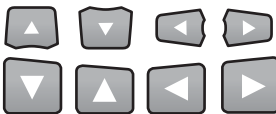

- Use  buttons to navigate menu,  adjust menu settings.

- A. Press 'MENU' button on the remote controller.
The following will appear on the screen.

MENU	
AUTO SCAN	[OFF]
OSD	[OFF]
INPUT	[AUTO]
TRIGGER TIME	[800ms]
TRIGGER PRID	[REAR]
ASPECT	[WIDE]

AUTO SCAN : Automatic scan when connected to video cable

OSD : [ON] - OSD remains on when camera is toggled

[OFF] - OSD appears up to 5 sec when camera is toggled

INPUT : [Auto] - Rear & Side view cameras automatically selected (input on mode)

[Manual] - Rear & Side view cameras manually selected (input on mode)

TRIGGER : Set the priority video source when more than two trigger signals enter at the same time.

ASPECT : Picture ratio control. (Wide - 16:9 / Normal - 4:3) 7 inch only.

- B. Press 'MENU' button twice on the remote controller.
The following will appear on the screen.

MENU			
	MIRROR	SCALE	SCAN-TIME
RIGHT	[OFF]	[OFF]	[0 sec]
REAR	[OFF]	[OFF]	[0 sec]
LEFT	[OFF]	[OFF]	[0 sec]

MIRROR : Set mirror option for each video source

SCALE : Ability to set scale for each video source

SCAN-TIME : Ability to set the delaytime for scanning from 0 to 9 seconds

- C. Press 'MENU' button three times on the remote controller.
The following will appear on the screen.

MENU	
BRIGHTNESS	[25]
CONTRAST	[25]
COLOR	[25]
TINT	[25]
SYSTEM	[NTSC]
AUTO-ON	[ON]
PRESET	[OFF]

BRIGHT : Adjust the brightness of the screen

CONTRAST : Adjust the contrast of the screen

COLOR : Adjust the color of the screen

TINT : Adjust the tint of the screen

SYSTEM : Adjust the video format. (NTSC/PAL)

AUTO-ON : The power of LCD stays on/off

PRESET : Default mode

Troubleshooting

SCREEN	<p>Q: Screen is too bright. A: Adjust BRIGHTNESS or CONTRAST. When pressing RESET button, it will go back to default setting.</p> <p>Q: Screen color is red or close to green. A: Adjust TINT in menu mode. Press preset to go back to default setting.</p> <p>Q: Colors are dim. A: Decrease the color by adjusting the button in menu mode.</p>
VIDEO	<p>Q: Screen is not clear. A: When the extension cable is too long diminishing of video may happen. Resolution might decrease due to protection of LCD window.</p> <p>Q: Sync signal distracts and the screen is black and white. A: Change the SYSTEM in menu.</p>
AUDIO	<p>Q: Sound cannot be heard in Audio. A: Check to see if it is in mute setting. Audio available only when vehicle is in reverse.</p>
POWER	<p>Q: Power does not turn on. A: Check if power is in DC12-32V. Red: +Power, Black: GND In order to set the power automatically set Auto-On in menu mode.</p>
TRIGGER	<p>Q: When in trigger mode, Scale does not appear on. A: Set the SCALE [ON] in menu mode.</p>

Operation Error	<p>Q: Motorized camera does not operate. A: Check if motorized camera is connected with REAR. Check if source switches are in REAR mode.</p> <p>Q: Auto scan does not operate. A: Scan does not operate when there is only one camera image.</p> <p>Q: Auto scan mode is too fast. A: Adjust S.TIME in appropriate level in menu mode.</p> <p>Q: OSD disappears in the screen. A: Set OSD [OFF] to [ON] in menu mode.</p> <p>Q: The screen does not change when entering trigger. A: Set INPUT [Auto] in menu mode.</p> <p>Q: The screen blinks when entering trigger. A: Increase TRIGGER TIME in menu mode.</p>
------------------------	---

Specifications

		5 Inch Series	5 Inch Series(Optional)	7 Inch Series
LCD	TYPE	TFT-LCD COLOR		
	SCREEN SIZE	5 Inch	5 Inch	7 Inch
	BRIGHTNESS	400 cd/m ²	400 cd/m ²	450 cd/m ²
	VISUAL FIELD (ANGLE)	Left 55°/ Right 55°/ Up 15°/ Down 35°	Left 45°/ Right 45°/ Up 25°/ Down 45°	Left 75°/ Right 75°/ Up 55°/ Down 60°
	CONTRAST	150 : 1	350 : 1	550 : 1
	MTBF	20,000 ~ 30,000 Hours	20,000 ~ 30,000 Hours	20,000 ~ 30,000 Hours
INPUT SIGNAL FEATURE		COMPOSITE (75)		
POWER CONSUMPTION		7.2W (Monitor only)	7.2W (Monitor only)	9.6W (Monitor only)
SIZE(Width x Depth x Height)		5.9 x 1.3 x 4.9 inch	5.9 x 1.3 x 4.9 inch	7.7 x 1.3 x 5.7 inch
POWER SOURCE		DC +12V ~ +32V		
TEMPERATURE	WORKING	-4°F~158°F(-20°C~70°C)		-22°F~176°F(-30°C~80°C)
	STORAGE	-13°F~180°F(-25°C~80°C)		-22°F~186°F(-30°C~85°C)

Dimensions

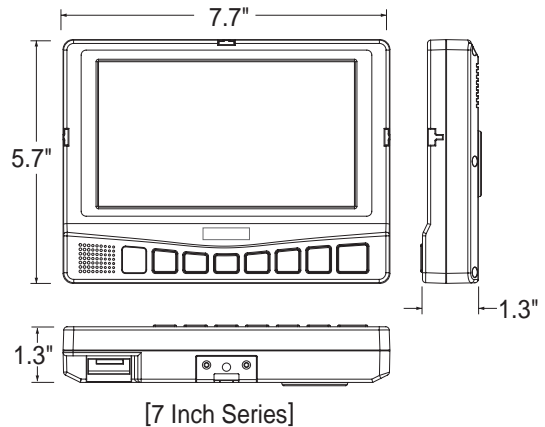
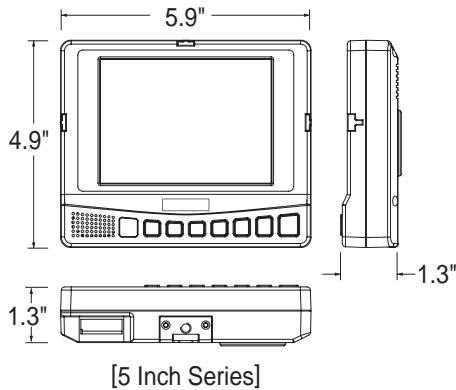

Made in Korea

Patent pending.

Design and specifications are subject to change without prior notice.